

Driver LC 75W 24V IP67 L EXC UNV

excite series 24 V – not dimmable (IP67)

Product description

- Constant voltage LED driver
- Universal input voltage range
- Max. output power 75 W
- Nominal lifetime up to 50,000 h
- 5 years guarantee (conditions at www.tridonic.com)

Housing properties

- Casing: aluminum, grey
- Type of protection IP67
- Dry, damp and wet location
- Potted version: higher protection against corrosion

Functions

- Overtemperature protection
- Overload protection
- Short-circuit protection
- No-load protection



Standards, page 3

Wiring diagrams and installation examples, page 3

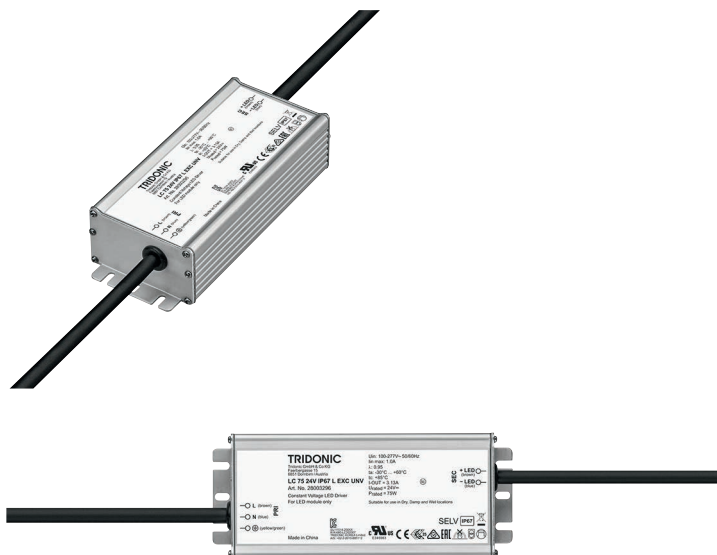



Driver LC 75W 24V IP67 L EXC UNV

excite series 24 V – not dimmable (IP67)

Technical data

| | |
|---|------------------|
| Rated supply voltage | 100 – 277 V |
| AC voltage range | 90 – 305 V |
| Mains frequency | 50 / 60 Hz |
| Rated current (at 120 V, 60 Hz) | 1 A |
| Rated current (at 230 V, 50 Hz) | 1 A |
| Rated current (at 277 V, 60 Hz) | 1 A |
| Leakage current (at 120 V, 60 Hz, full load) | < 750 µA |
| Leakage current (at 230 V, 50 Hz, full load) | < 750 µA |
| Leakage current (at 277 V, 60 Hz, full load) | < 750 µA |
| Efficiency (at 120 V, 60 Hz) | > 84 % |
| Efficiency (at 230 V, 50 Hz) | > 86 % |
| Efficiency (at 277 V, 60 Hz) | > 86 % |
| λ (at 120 V, 60 Hz) | 0.98 |
| λ (at 230 V, 50 Hz) | 0.95 |
| λ (at 277 V, 60 Hz) | 0.9C |
| Typ. input power in no-load operation | 1.08 W |
| Output voltage tolerance | 22.8 – 25.2 V |
| Max. output power | 75 W |
| Output LF voltage ripple (< 120 Hz) | ± 5 % |
| Starting time (output) | ≤ 500 ms |
| Hold on time at power failure (output) | ≤ 1 ms |
| Mains burst capability | 1 kV |
| Mains surge capability (between L – N) | 4 kV |
| Mains surge capability (between L/N – PE) | 10 kV |
| Surge voltage at output side (against PE) | < 500 V |
| Max. casing temperature tc | 85 °C |
| Ambient temperature ta (at lifetime 50,000 h) | 50 °C |
| Storage temperature | -40 ... +85 °C |
| Type of protection | IP67 |
| Lifetime | up to 50,000 h |
| Guarantee (conditions at www.tridonic.com) | 5 years |
| Dimensions LxWxH | 164 x 68 x 39 mm |
| Hole spacing D | 149 mm |

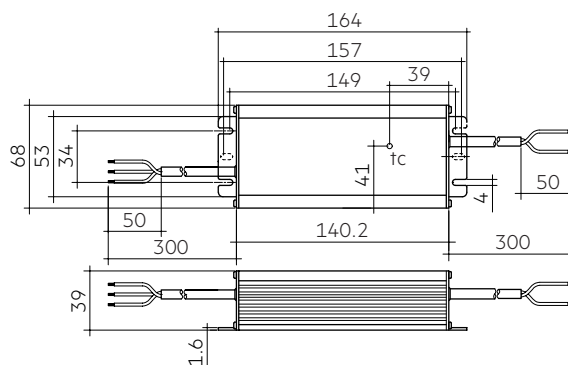

Dimensions in mm

Ordering data

| Type | Article number | Packaging carton | Packaging pallet | Weight per pc. |
|---------------------------|----------------|------------------|------------------|----------------|
| LC 75W 24V IP67 L EXC UNV | 28003296 | 10 pc(s). | 240 pc(s). | 0.73 kg |

Specific technical data

| Type | Load | Forward voltage | Output current | Max. output power | Typ. power consumption (at 120 V, 60 Hz) | Typ. current consumption (at 120 V, 60 Hz) | Typ. power consumption (at 230 V, 50 Hz) | Typ. current consumption (at 230 V, 50 Hz) | Typ. power consumption (at 277 V, 60 Hz) | Typ. current consumption (at 277 V, 60 Hz) | Ambient temperature ta max. |
|---------------------------|-------|-----------------|----------------|-------------------|--|--|--|--|--|--|-----------------------------|
| LC 75W 24V IP67 L EXC UNV | 10 % | 23.9 V | 314 mA | 7.5 W | 10.3 W | 95 mA | 10.6 W | 69 mA | 10.1 W | 70 mA | -40 ... 60 °C |
| | 20 % | 23.9 V | 627 mA | 15.0 W | 19.3 W | 168 mA | 19.6 W | 103 mA | 19.5 W | 96 mA | -40 ... 60 °C |
| | 30 % | 23.8 V | 939 mA | 22.4 W | 27.4 W | 234 mA | 27.5 W | 136 mA | 27.7 W | 121 mA | -40 ... 60 °C |
| | 40 % | 23.8 V | 1,252 mA | 29.9 W | 35.6 W | 301 mA | 35.5 W | 170 mA | 35.9 W | 161 mA | -40 ... 60 °C |
| | 50 % | 23.8 V | 1,565 mA | 37.3 W | 43.8 W | 369 mA | 43.4 W | 201 mA | 43.6 W | 188 mA | -40 ... 60 °C |
| | 60 % | 23.8 V | 1,878 mA | 44.8 W | 52.3 W | 439 mA | 51.5 W | 235 mA | 51.6 W | 208 mA | -40 ... 60 °C |
| | 70 % | 23.8 V | 2,191 mA | 52.2 W | 60.8 W | 509 mA | 59.7 W | 270 mA | 59.6 W | 234 mA | -40 ... 60 °C |
| | 80 % | 23.8 V | 2,503 mA | 59.7 W | 69.2 W | 580 mA | 67.7 W | 304 mA | 67.6 W | 259 mA | -40 ... 60 °C |
| | 90 % | 23.8 V | 2,816 mA | 67.1 W | 77.8 W | 651 mA | 75.9 W | 339 mA | 75.7 W | 287 mA | -40 ... 60 °C |
| | 100 % | 23.8 V | 3,130 mA | 74.5 W | 86.3 W | 722 mA | 85.0 W | 373 mA | 83.8 W | 316 mA | -40 ... 60 °C |

1. Standards

EN 55015
EN 61000-3-2
EN 61000-3-3
EN 61347-1
EN 61347-2-13
EN 62384
EN 60598-1
UL8750

2. Thermal details and lifetime

2.1 Expected lifetime

120 V, 60 Hz

| Type | Output voltage | ta | 55 °C | 60 °C | 65 °C | 70 °C |
|---------------------------|----------------|----------|------------|------------|------------|------------|
| LC 75W 24V IP67 L EXC UNV | 24 V | tc | 80 °C | 85 °C | 90 °C | 95 °C |
| | | Lifetime | > 45,000 h | > 30,000 h | > 20,000 h | > 15,000 h |

230 V, 50 Hz

| Type | Output voltage | ta | 55 °C | 60 °C | 65 °C | 70 °C |
|---------------------------|----------------|----------|------------|------------|------------|------------|
| LC 75W 24V IP67 L EXC UNV | 24 V | tc | 75 °C | 80 °C | 85 °C | 90 °C |
| | | Lifetime | > 90,000 h | > 60,000 h | > 45,000 h | > 30,000 h |

277 V, 60 Hz

| Type | Output voltage | ta | 55 °C | 60 °C | 65 °C | 70 °C |
|---------------------------|----------------|----------|------------|------------|------------|------------|
| LC 75W 24V IP67 L EXC UNV | 24 V | tc | 65 °C | 70 °C | 75 °C | 80 °C |
| | | Lifetime | > 90,000 h | > 60,000 h | > 45,000 h | > 30,000 h |

3. Installation / Wiring

3.1 Wiring diagram

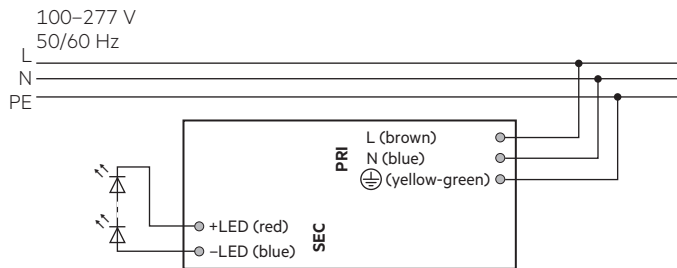

3.2 Connection

| Primary cable | | | Secondary cable | |
|---------------|------|--------------|-----------------|------|
| L | N | PE | + | - |
| brown | blue | yellow-green | brown | blue |

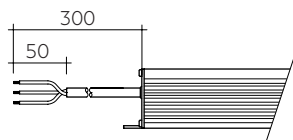

PRI:
3x1.0 mm²

SEC:
2x1.0 mm²

3.3 Wiring guidelines

- All connections must be kept as short as possible to ensure good EMI behaviour.
- To comply with the EMC regulations run the secondary wires (LED module) in parallel.
- Mains leads should be kept apart from LED driver and other leads (ideally 5 – 10 cm distance)
- Max. length of output wires is 2 m.
- Secondary switching is not permitted.
- Incorrect wiring can damage LED modules.
- To avoid the damage of the Driver, the wiring must be protected against short circuits to earth (sharp edged metal parts, metal cable clips, louver, etc.).

3.4 Hot plug-in

Hot plug-in is supported.

3.5 Earth connection

The earth connection is conducted as protection earth (PE). The LED driver can be earthed via metal housing. If the LED driver will be earthed, protection earth (PE) has to be used. There is no earth connection required for the functionality of the LED driver. Earth connection is recommended to improve following behaviour:

- Electromagnetic interferences (EMI)
- LED glowing at standby
- Transmission of mains transients to the LED output

In general it is recommended to earth the LED driver if the LED module is mounted on earthed luminaire parts respectively heat sinks and thereby representing a high capacity against earth.

3.6 Installation instructions

The functioning of the LC in combination with dimming devices (e.g. PWM) cannot be guaranteed and has to be checked individually before using in combination.

For fulfilling the ecodesign requirements of the European Union following has to be considered:

- Going to stand-by via PWM dimmer is not supported.
- To turn off the luminaire, mains has to be off.

4. Electrical values

4.1.1 Efficiency vs. load 120 V, 60 Hz

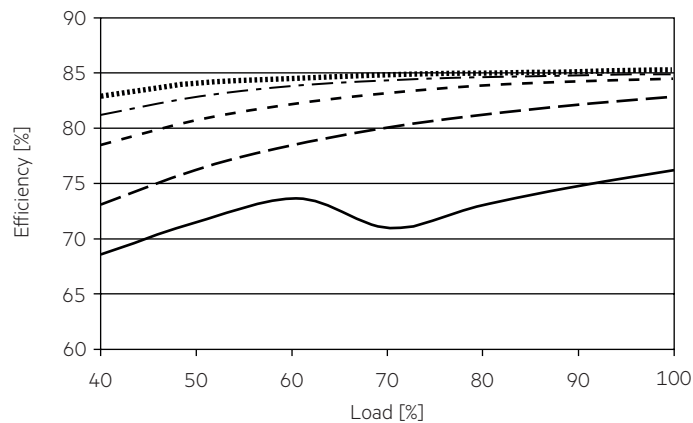

4.1.2 Efficiency vs. load 230 V, 50 Hz

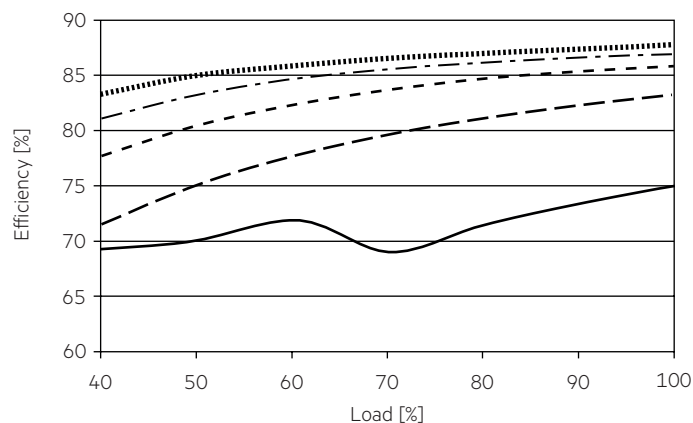

4.1.3 Efficiency vs. load 277 V, 60 Hz

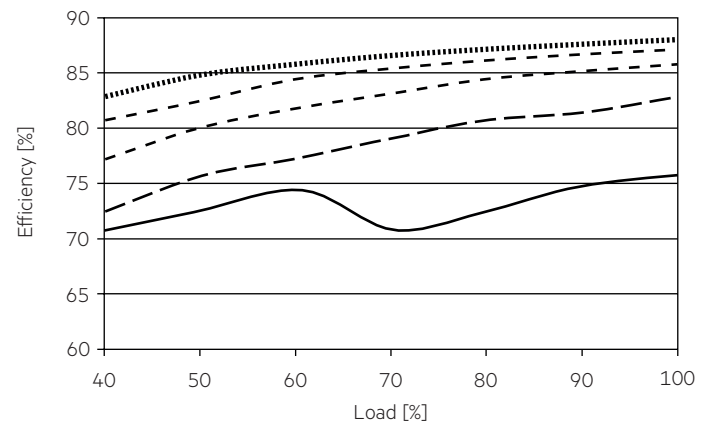

4.2.1 Power factor vs. load 120 V, 60 Hz

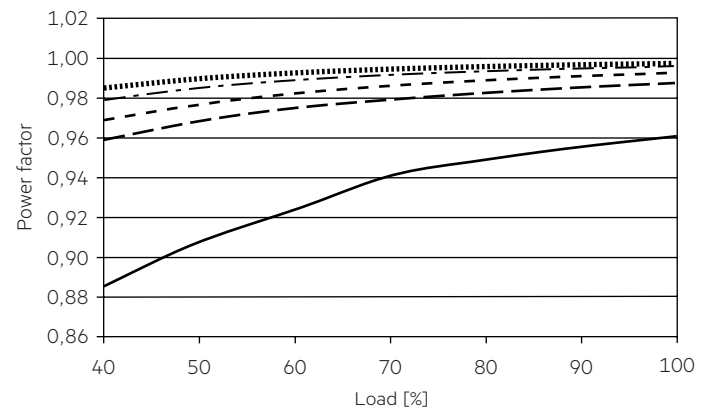

4.2.2 Power factor vs. load 230 V, 50 Hz

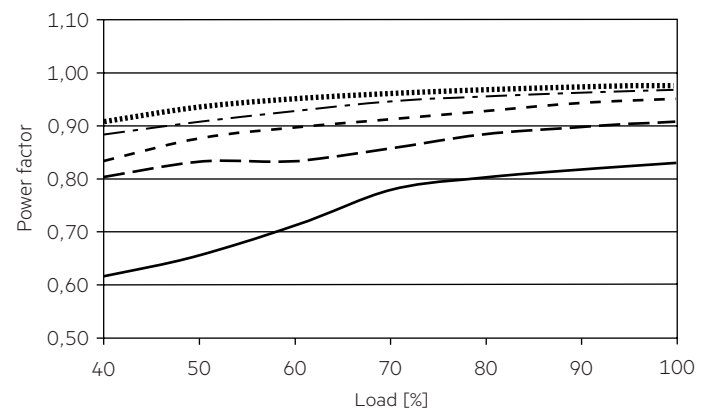

4.2.3 Power factor vs. load 277 V, 60 Hz

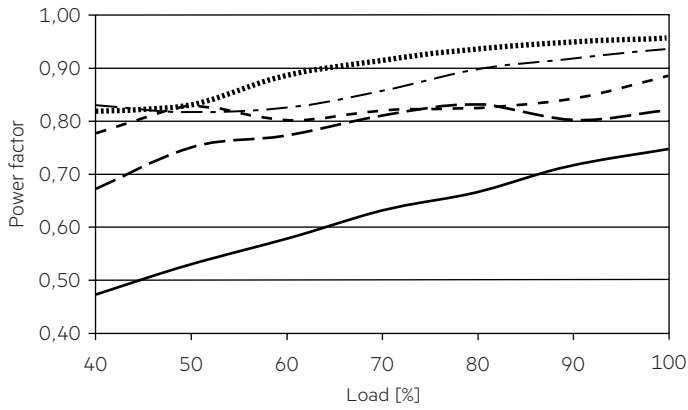

4.3.3 THD vs. load 277 V, 60 Hz

THD without harmonic < 5 mA or 0.6 % of the input current.

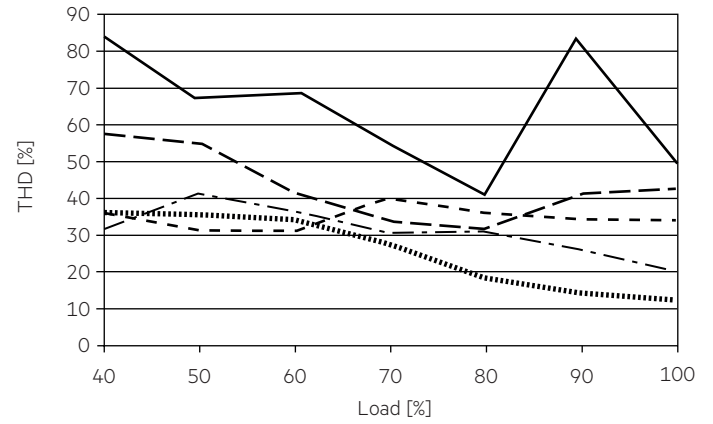

4.3.1 THD vs. load 120 V, 60 Hz

THD without harmonic < 5 mA or 0.6 % of the input current.

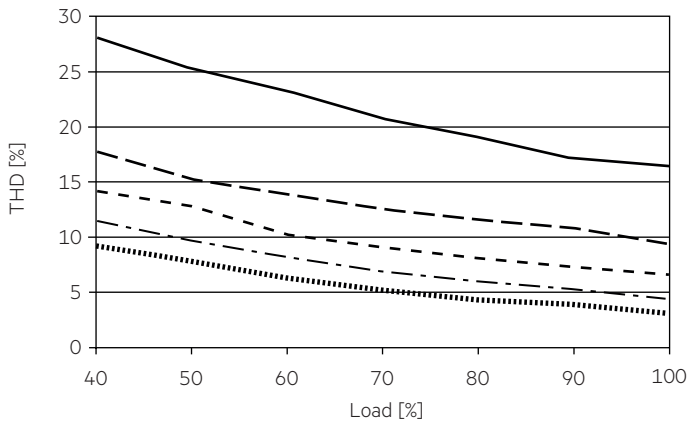

4.4.1 Input current vs. load 120 V, 60 Hz

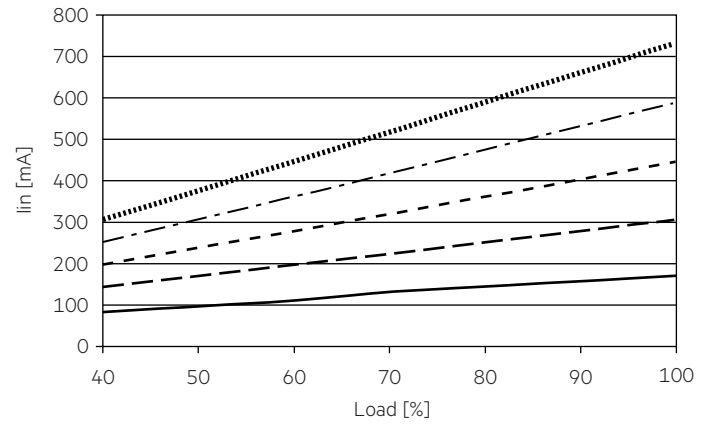

4.3.2 THD vs. load 230 V, 50 Hz

THD without harmonic < 5 mA or 0.6 % of the input current.

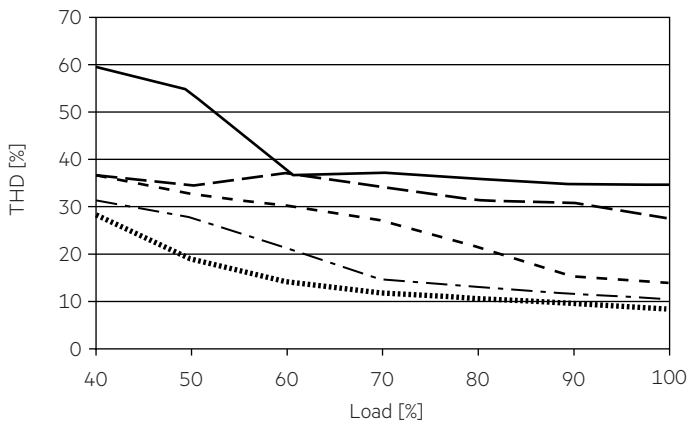

4.4.2 Input current vs. load 230 V, 50 Hz

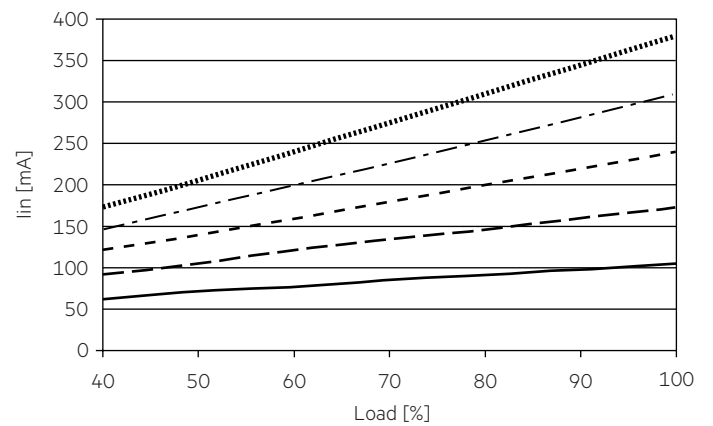

4.4.3 Input current vs. load 277 V, 60 Hz

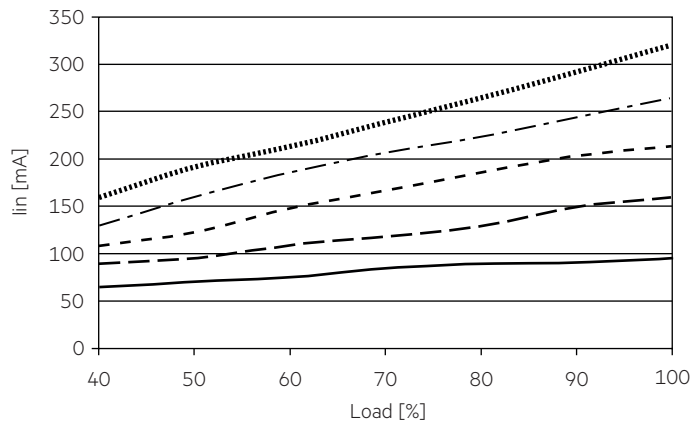

4.5.3 Input power vs. load 277 V, 60 Hz

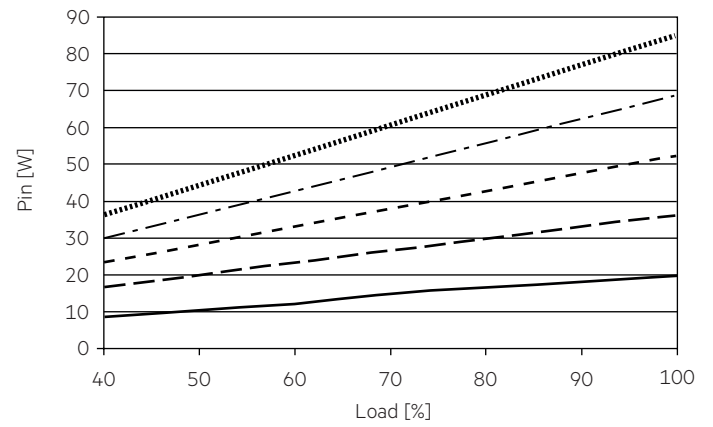

4.5.1 Input power vs. load 120 V, 60 Hz

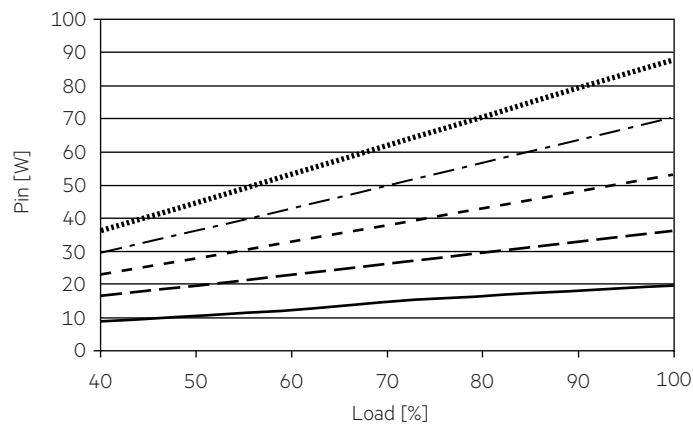

- 15 W
- - - 30 W
- - - 45 W
- - - 60 W
- 75 W

4.5.2 Input power vs. load 230 V, 50 Hz

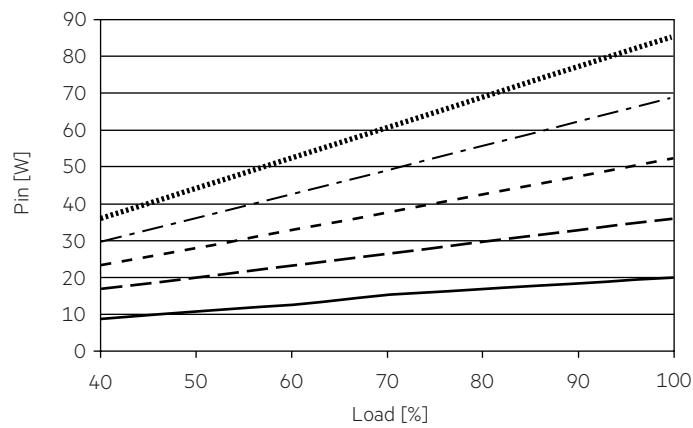

4.6 Maximum loading of automatic circuit breakers

Maximum loading of automatic circuit breakers at 120 V, 60 Hz

| Automatic circuit breaker type | C10 | C13 | C16 | C20 | B10 | B13 | B16 | B20 | Inrush current | |
|----------------------------------|---------------------|---------------------|---------------------|---------------------|---------------------|---------------------|---------------------|---------------------|------------------|--------|
| Installation Ø | 1.5 mm ² | 1.5 mm ² | 2.5 mm ² | 2.5 mm ² | 1.5 mm ² | 1.5 mm ² | 2.5 mm ² | 2.5 mm ² | I _{max} | time |
| LC 75W 24V IP67 L EXC UNV | 5 | 6 | 8 | 10 | 3 | 4 | 5 | 6 | 26 A | 528 µs |

Maximum loading of automatic circuit breakers at 230 V, 50 Hz

| Automatic circuit breaker type | C10 | C13 | C16 | C20 | B10 | B13 | B16 | B20 | Inrush current | |
|----------------------------------|---------------------|---------------------|---------------------|---------------------|---------------------|---------------------|---------------------|---------------------|------------------|--------|
| Installation Ø | 1.5 mm ² | 1.5 mm ² | 2.5 mm ² | 2.5 mm ² | 1.5 mm ² | 1.5 mm ² | 2.5 mm ² | 2.5 mm ² | I _{max} | time |
| LC 75W 24V IP67 L EXC UNV | 5 | 6 | 8 | 10 | 3 | 4 | 5 | 6 | 45 A | 452 µs |

Maximum loading of automatic circuit breakers at 277 V, 60 Hz

| Automatic circuit breaker type | C10 | C13 | C16 | C20 | B10 | B13 | B16 | B20 | Inrush current | |
|----------------------------------|---------------------|---------------------|---------------------|---------------------|---------------------|---------------------|---------------------|---------------------|------------------|--------|
| Installation Ø | 1.5 mm ² | 1.5 mm ² | 2.5 mm ² | 2.5 mm ² | 1.5 mm ² | 1.5 mm ² | 2.5 mm ² | 2.5 mm ² | I _{max} | time |
| LC 75W 24V IP67 L EXC UNV | 5 | 6 | 8 | 10 | 3 | 4 | 5 | 6 | 56 A | 467 µs |

4.7 Harmonic distortion in mains supply in %

120 V, 60 Hz:

| Type | THD | 3 | 5 | 7 | 9 | 11 |
|----------------------------------|------|------|------|-----|-----|-----|
| LC 75W 24V IP67 L EXC UNV | < 15 | < 12 | < 10 | < 7 | < 5 | < 3 |

230 V, 50 Hz:

| Type | THD | 3 | 5 | 7 | 9 | 11 |
|----------------------------------|------|------|------|-----|-----|-----|
| LC 75W 24V IP67 L EXC UNV | < 15 | < 12 | < 10 | < 7 | < 5 | < 3 |

277 V, 60 Hz:

| Type | THD | 3 | 5 | 7 | 9 | 11 |
|----------------------------------|------|------|------|-----|-----|-----|
| LC 75W 24V IP67 L EXC UNV | < 15 | < 12 | < 10 | < 7 | < 5 | < 3 |

Acc. to 6100-3-2. Harmonics < 5 mA or < 0.6 % (whatever is greater) of the input current are not considered for calculation of THD.

5. Functions

5.1 Short-circuit behaviour

In case of a short circuit on the secondary side (LED) the LED driver switches off. After elimination of the short-circuit fault the LED driver will recover automatically.

5.2 No-load operation

The LED driver will not be damaged in the no-load operation. A voltage of 25.2V DC is permanent at the output.

5.3 Over load protection

If the maximum load is exceeded by a defined internal limit, the LED driver enter hiccup modus. After elimination of the overload fault the LED driver will recover automatically.

5.4 Over temperature protection

Over temperature protection will be activated for $t_c > 90^\circ\text{C}$. The Driver is shot down when over temperature protection triggered. Auto-recovery when fault condition removed.

6. Miscellaneous

6.1 Insulation and electric strength testing of luminaires

Electronic devices can be damaged by high voltage. This has to be considered during the routine testing of the luminaires in production.

According to UL 8750 (informative only!) each luminaire should be submitted to an insulation test with 500 V_{DC}. The dielectric withstand test equipment shall employ a transformer of 500-VA or larger capacity and have a variable output voltage that is essentially sinusoidal or continuous direct current. The applied potential is to be increased from zero at a substantially uniform rate until the required test level is reached, and is to be held at that level for 1 minute.

As an alternative, UL8750 (informative only!) describes a test of the electrical strength with 2V AC + 1000V (or 1.414 x V DC). To avoid damage to the electronic devices this test must not be conducted.

6.2 Conditions of use and storage

Humidity: 10 % up to max. 95 %, not condensed (max. 56 days/year at 95 %)

Storage temperature: -40 °C up to max. +85 °C

The devices have to be within the specified temperature range (ta) before they can be operated.

The LED driver is declared as inbuilt LED controlgear, meaning it is intended to be used within a luminaire enclosure. If the product is used outside a luminaire, the installation must provide suitable protection for people and environment (e.g. in illuminated ceilings).

6.3 Additional information

Additional technical information at www.tridonic.com → Technical Data

Lifetime declarations are informative and represent no warranty claim. No warranty if device was opened.